

# Vampire

model Matt Slayton  
diagrams Alex Barber  
copyright nineteen ninety four

1

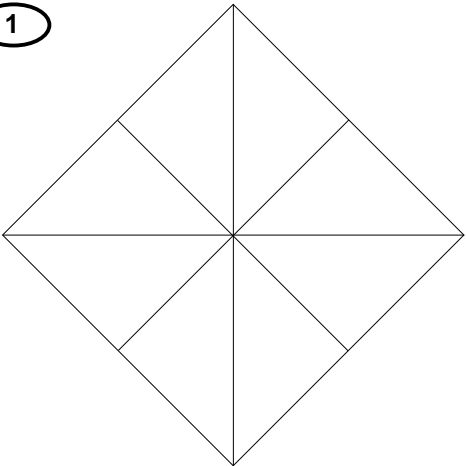

start with white side up

2

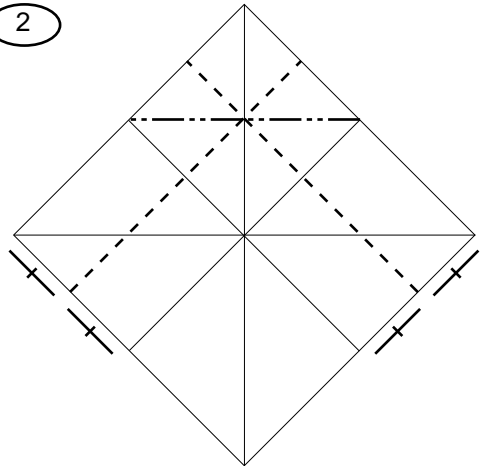

make a preliminary base...

3

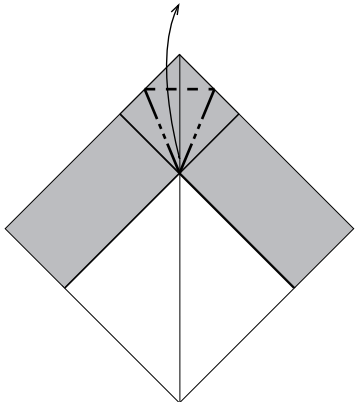

...then a bird base

4

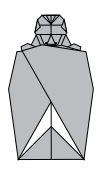
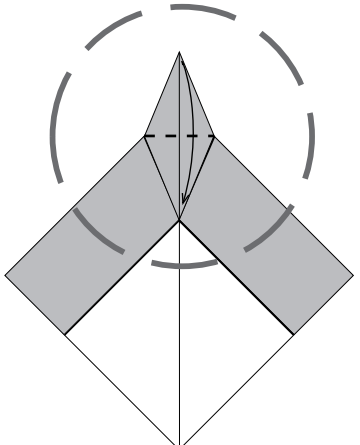

ONE

5

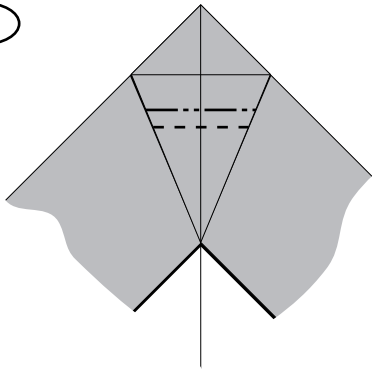

6

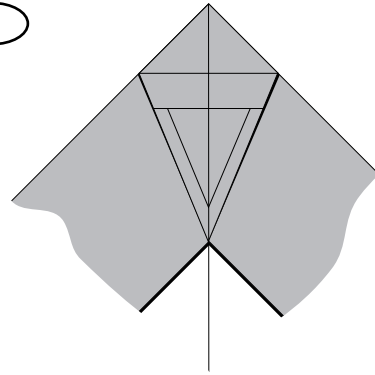

pleat the brow...

7

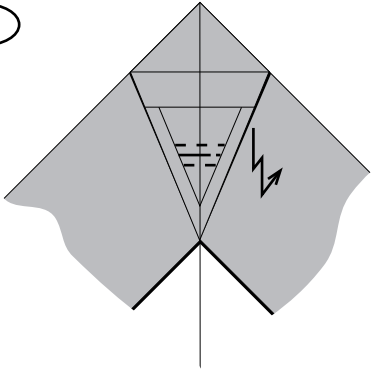

8

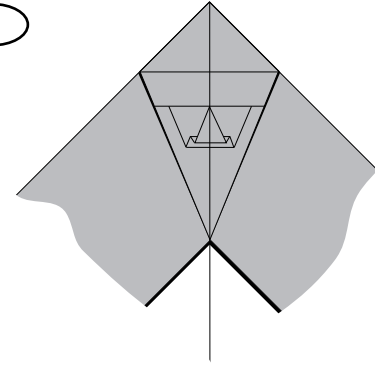

...and the nose

9

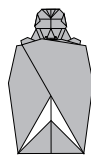
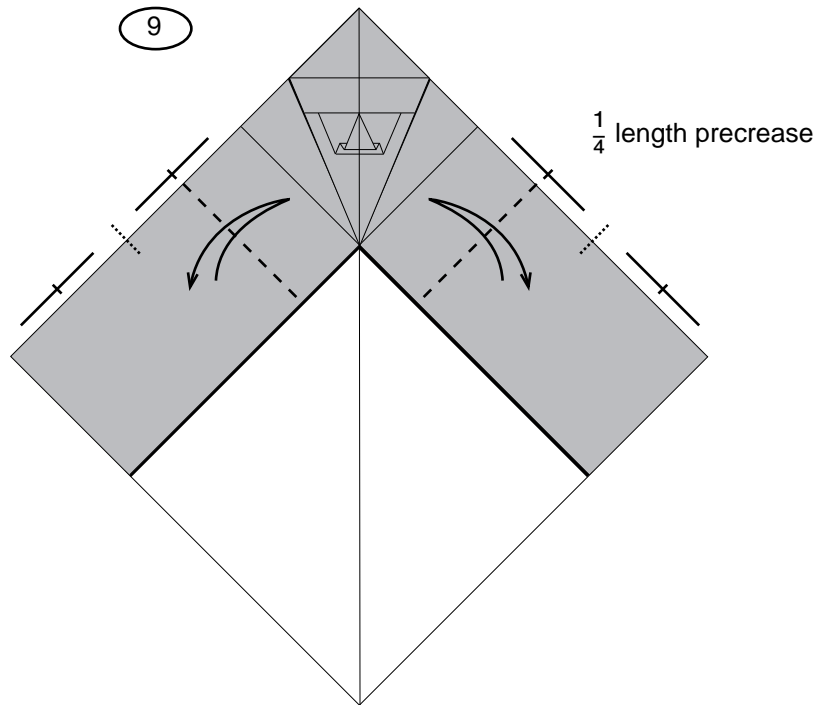

two

10

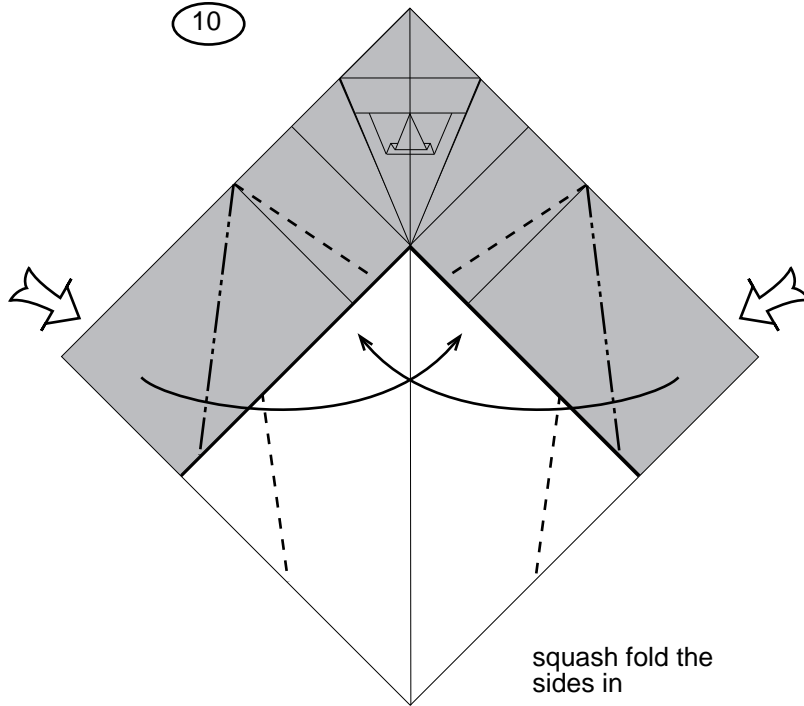

11

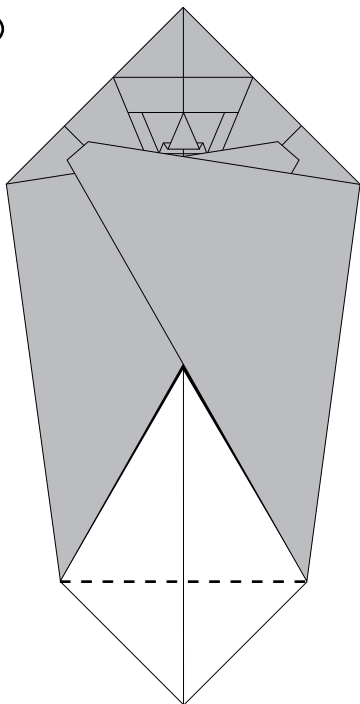

12

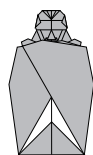
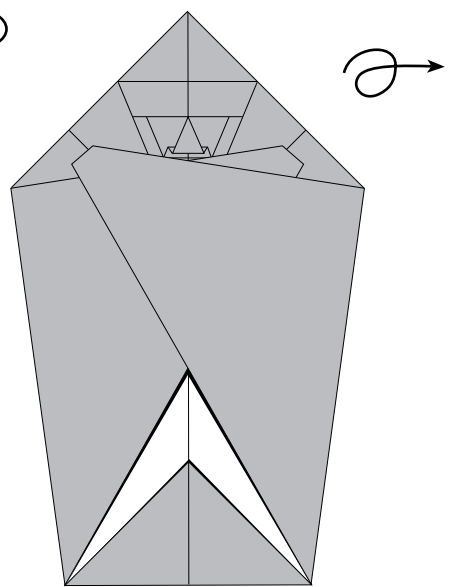

three

13

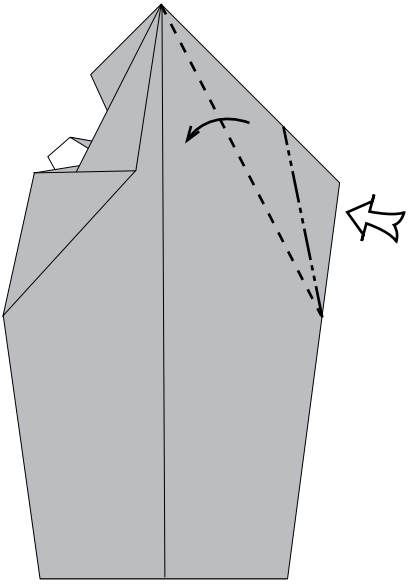

squash fold the sides, but not to the center

14

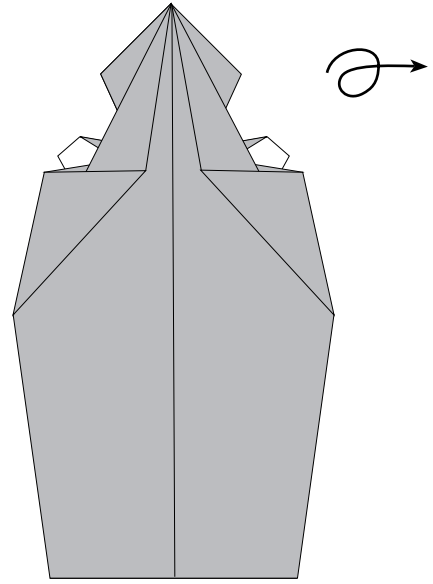

15

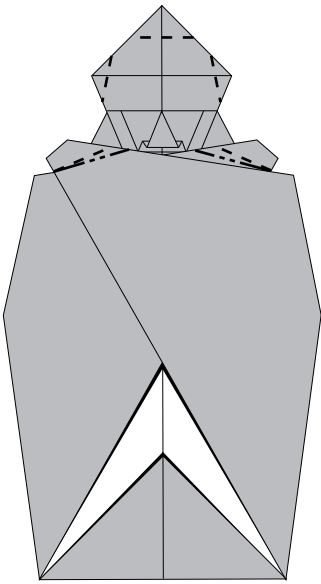

crimp the hands and finish shaping the head

16

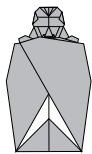
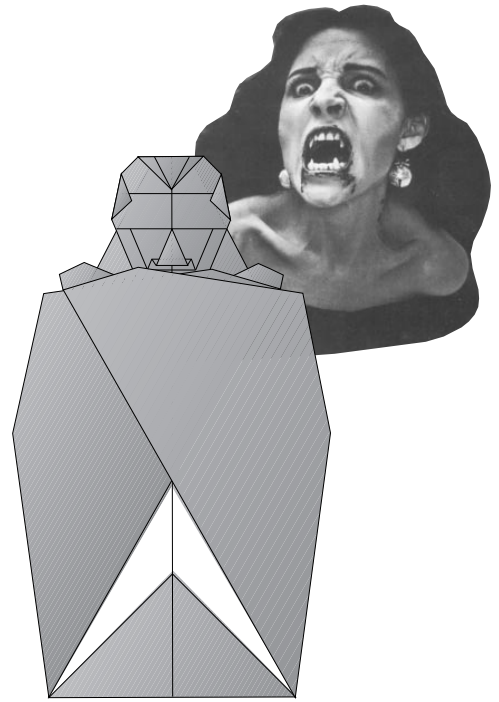

FOUR